

## GAS FLOWMETER GD 300/GD 500 Ex

for measuring all technical and medical gases from DN 15 to DN 400

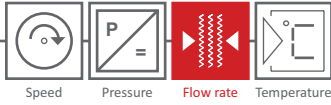



## Overview



Rev.-no.: GD 300-DS 312 E-V1.4 2015-03-18

- oscillating measurement principle, without moving parts
- measuring housing, orifice and measuring labyrinth made of stainless steel, also available as heavy duty construction
- resistant to dirt, e.g. oil, rust, sulphur
- excellent results measuring moist gases with condensate
- mounting in falling direction into gas lines even for 100 % damp biogas due to integrated condensate discharge
- optional integrated ball valve (blocking valve) in the GD 300 for removal/installation of the platinum sensor without emptying the system
- integrated calculator HB 300 in the measuring head with mA- (normalization optional) or pulse output
- optional redundant measuring method with two independent platinum wire sensors and two separate flow computer
- short response time  $T_{90} \leq 50$  ms with a flow velocity  $\geq 0,25$  m/s
- high accuracy ( $\pm 1,5$  % of true value)
- high reproducibility (0,1 % of true value)
- low pressure loss
- each flowmeter with calibration report
- recalibration not required
-  II 1 / 2 G Ex ia / e mb IIC T4 Ga / Gb (certificate no. EX5 13 07 14689 003)

**NEW!**

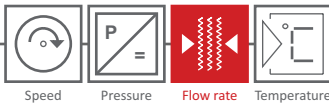

## Redundant Measurement Method (optional)

The redundant measurement method relies on two separate platinum wire sensors which are integrated in the measuring head of the GD 300/GD 500 (only devices without ATEX certification). The sensors are connected with two separate cables to two separate monitors.

The evaluation devices operate in hot stand-by mode. In trouble-free operation the secondary unit takes over the current counter reading of the primary device via CAN-bus in a 100 ms cycle.

In case of an incident of the primary system (platinum wire sensor break damage, loss of pressure and temperature measurement, failure of the primary volume corrector) the secondary system takes over all functions within 100 ms. After repair of the primary system it automatically resumes the current counters from the secondary system. In the event of a failure of the secondary system, it can be changed without affecting the primary system.

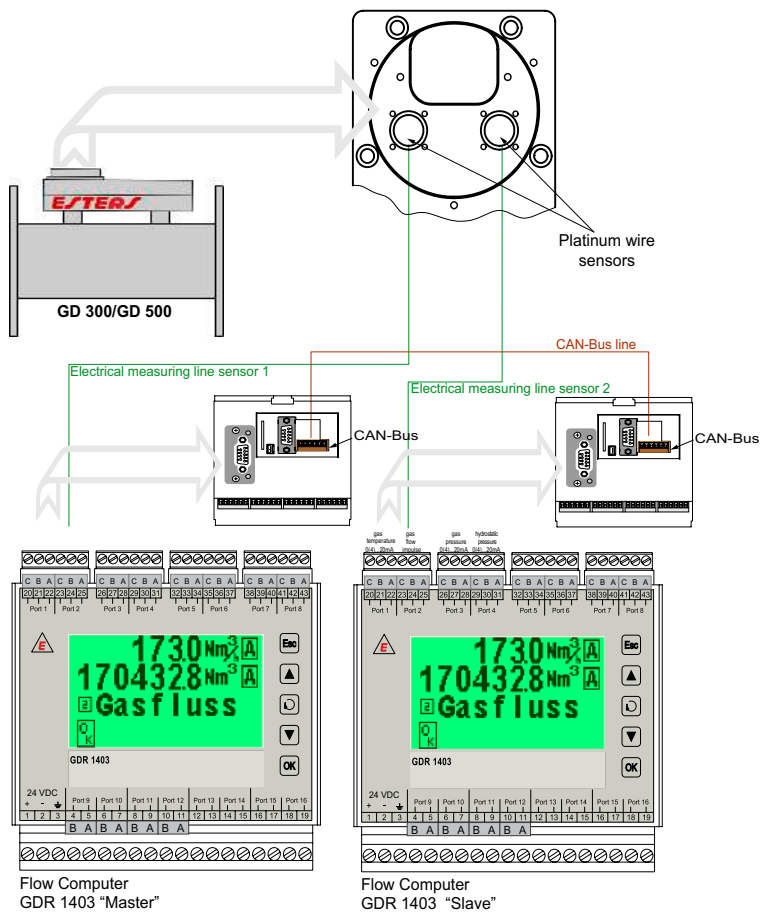

measuring head with two sensors

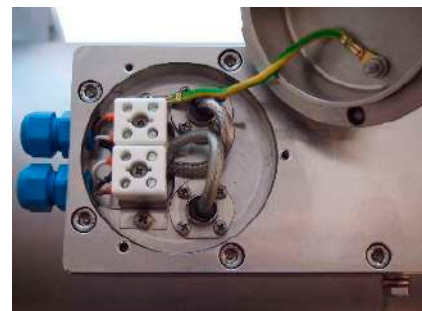

connectors of redundant system in the measuring head

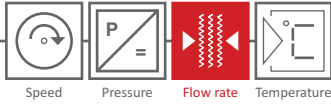

### Technical Details

	GD 500 WITH EXTERNAL PIPE THREAD	GD 300 WITH INTERNAL PIPE THREAD	GD 300 WITH FLANGE
			
NOMINAL SIZE	DN 15	DN 25 to DN 50	DN 50 to DN 400
PROCESS CONNECTION	external pipe thread R 1/2" G 1"	internal pipe thread Rp 1", Rp 1 1/4", Rp 1 1/2", Rp 2"	flange acc. to DIN EN-1092-2 or DIN 2576 depending on availability flange acc. to ASME B 16.5
PRESSURE RANGE	0,5 bar, 10 bar, 16 bar, 40 bar	0,5 bar, 10 bar, 16 bar, 40 bar	0,5 bar, 10 bar, 16 bar, 40 bar (ISO flange) class 150, class 300 (ASME flange)
TEMPERATURE	-20 bis +120°C; gas as well as environment, max. 80°C for the Ex version		
MEASURING HEAD	material stainless steel 1.4571 (V4A), stainless steel 1.4301 (V2A), aluminium		
MEASURING LABYRINTH	material stainless steel 1.4571 (V4A), stainless steel 1.4301 (V2A), aluminium		
TUBE BODY	-	material stainless steel 1.4571 (V4A), stainless steel 1.4301 (V2A), aluminium	material stainless steel 1.4571 (V4A)
SENSOR	material platinum		
PROTECTION CLASS	IP 65		
OUTPUT (STANDARD)	pulse output: pulse 24 V, DC, max. 200 Hz (pulse width 1 - 2 ms) status output for sensor break detection: 24 V, DC (pollution monitoring with redundant platinum wire sensor)		
OUTPUT WITH INTEGRATED CALCULATOR	pulse output: pulse 24 V, DC, 1 pulse=0.01, 0. 1, 1, 10 or 100 m <sup>3</sup> current interface: (0)4 - 20 mA = 0 - x Nm <sup>3</sup> /h , status output for sensor break detection: 24 V, DC (pollution monitoring with redundant platinum wire sensor) standard: DIN 1343, DIN 6358, DIN ISO 2533, DIN 102/ISO 1-1975 fixed value temperature: -50 °C to 200°C fixed value absolute pressure: -0,8 bar to 100 bar		
ATEX CERTIFICATION	 II 1 / 2 G Ex ia / e mb IIC T4 Ga / Gb, EG certificate no: TPS 13 ATEX 14689 003 X (certificate no. EX5 13 07 14689 003)		
ADDITIONAL SENSOR (OPTIONAL)	integrated pressure and temperature sensors (only devices without ATEX certification): P1: pressure: -50 ... +200 mbar, temperature: -50 to +150°C P2: pressure: 0 ... 30 bar, temperature: -50 to +150°C		
REDUNDANT VERSION (OPTIONAL)	redundant sensors in measuring head (only devices without ATEX certification): R1: redundant platinum sensor R2: redundant platinum sensor, pressure and temperature sensor		
BALL VALVE (OPTIONAL)	AVF - ball valve (blocking valve) for GD 300 with flange removal/installation of the platinum wire sensor without emptying the system		

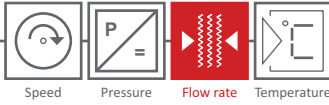

## Pressure Loss / Flow

The diagram applies to gases with a density of air at NTP (0°C and 1013 mbar). The decrease of pressure is always proportional to the gas density. If e.g. the operating pressure rises by 100% the pressure drop doubles.

### Flow rate vs. pressure loss

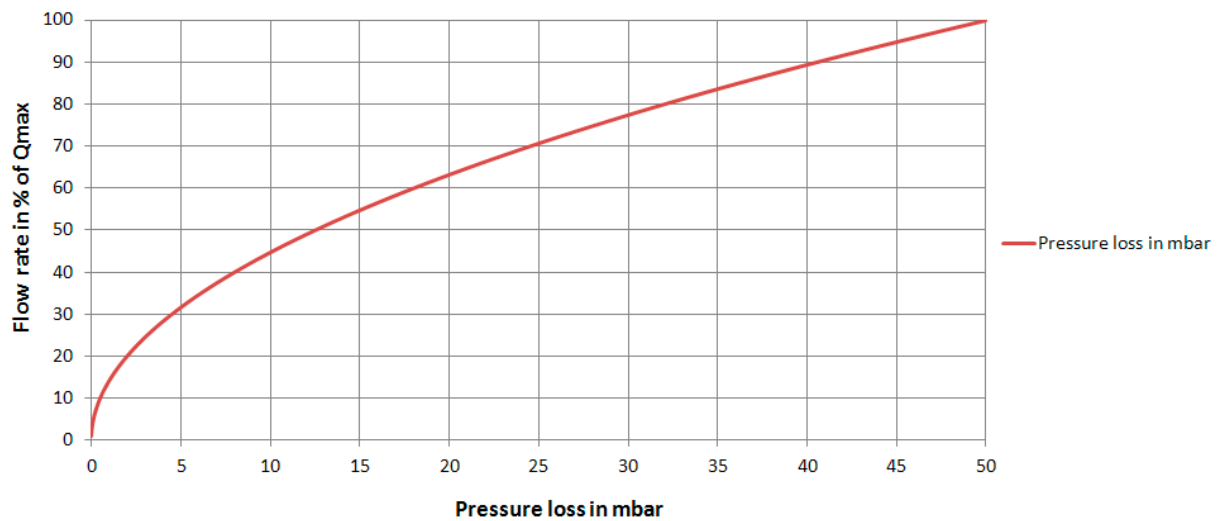

## Accuracy of Measurement

At low flow rates the density (or actually the viscosity) of the gas influences the accuracy.

Above the limit value ( $Q_l$ ), the accuracy is 1,5 % of the measured value. Below  $Q_l$  the accuracy is 5 % of the measured value.

Example measurement range:  
 $Q_l$  with 1,5% accuracy

DN (mm)	inches	m <sup>3</sup> /h		kg/Nm <sup>3</sup>	m <sup>3</sup> /h	
		$Q_{min}$ (5 %)	$Q_l$ (1,5 %)	density	%	$Q_{max}$
15	1/2"	0,06	3,52	0,5	16	22
80	3"	8,00	64	1,0	8	800
80	3"	8,00	48	1,2	6	800
150	10"	30,0	240	1,0	8	3.000
150	10"	30,0	180	1,2	6	3.000

Example:

At a density of  $x$  kg/m<sup>3</sup> the limit value is  $Q_l = y$  % of  $Q_{max}$ .

density kg/m <sup>3</sup>	=	limit value $Q_l$
0,5	=	16%
1,0	=	8%
1,2	=	6%
2,0	=	4%
4,0	=	2%
8,0	=	1%

For natural gas with a methane component of 85 % a density of 0,85 kg/m<sup>3</sup> is assumed.

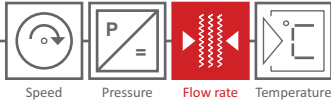

## Measuring Range

### GD 500 with external pipe thread

DN (mm)	inches	m <sup>3</sup> /h	
		Q <sub>min</sub>	Q <sub>max</sub>
15	1/2"	0,06	22
25	1"	0,06	22

### GD 300 with internal pipe thread

DN (mm)	m <sup>3</sup> /h					
	orifice 13		orifice 15		orifice 17	
	Q <sub>min</sub>	Q <sub>max</sub>	Q <sub>min</sub>	Q <sub>max</sub>	Q <sub>min</sub>	Q <sub>max</sub>
25	0,20	20	0,35	35	0,7	70
32	0,20	20	0,60	60	1,00	100
40	0,20	20	0,90	90	2,00	200
50	0,20	20	1,10	110	2,50	250

### GD 300 with flange

DN (mm)	m <sup>3</sup> /h					
	orifice 13		orifice 15		orifice 17	
	Q <sub>min</sub>	Q <sub>max</sub>	Q <sub>min</sub>	Q <sub>max</sub>	Q <sub>min</sub>	Q <sub>max</sub>
50	0,20	20	1,10	110	2,50	250
65	0,90	90	1,70	170	4,50	450
80	1,40	140	4,50	450	8,00	800

DN (mm)	m <sup>3</sup> /h					
	orifice 25		orifice 27		orifice 30	
	Q <sub>min</sub>	Q <sub>max</sub>	Q <sub>min</sub>	Q <sub>max</sub>	Q <sub>min</sub>	Q <sub>max</sub>
100	2,70	270	6,50	650	10,00	1.000
125	4,00	400	8,00	800	15,00	1.500
150	6,00	600	12,00	1.200	30,00	3.000
200	12,00	1.200	25,00	2.500	60,00	6.000
250	20,00	2.000	40,00	4.000	75,00	7.500
300	30,00	3.000	50,00	5.000	113,00	13.000
350	40,00	4.000	70,00	7.000	140,00	14.000
400	50,00	5.000	100,00	10.000	160,00	16.000

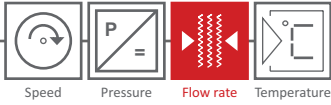

## Dimensions and Weight

### GD 500 with external pipe thread

inches	weight (kg) <sup>+5%</sup>
1/2"	8
1"	8

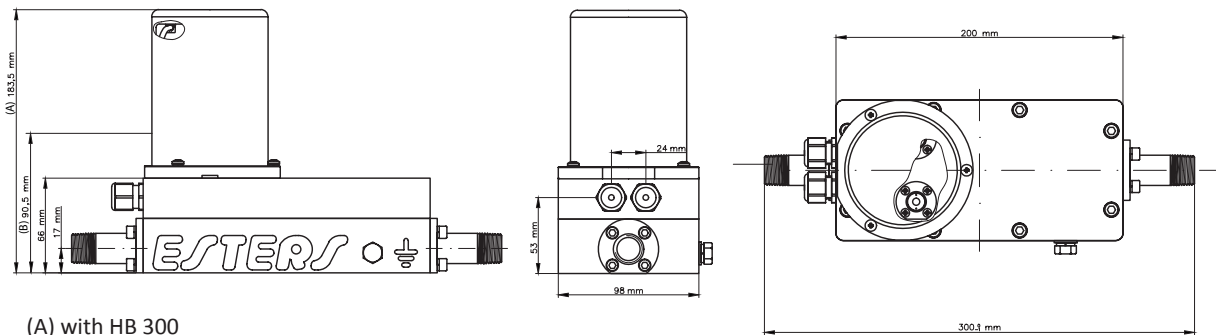

(A) with HB 300  
(B) without HB 300

### GD 300 with internal pipe thread

mm <sup>+0-1</sup> DN (nominal size)	inches thread	mm <sup>+0-1</sup> J	weight (kg) <sup>+ -5%</sup>
25	Rp 1"	80	16
32	Rp 1 1/4"	80	12
40	Rp 1 1/2"	100	18
50	Rp 2"	100	14

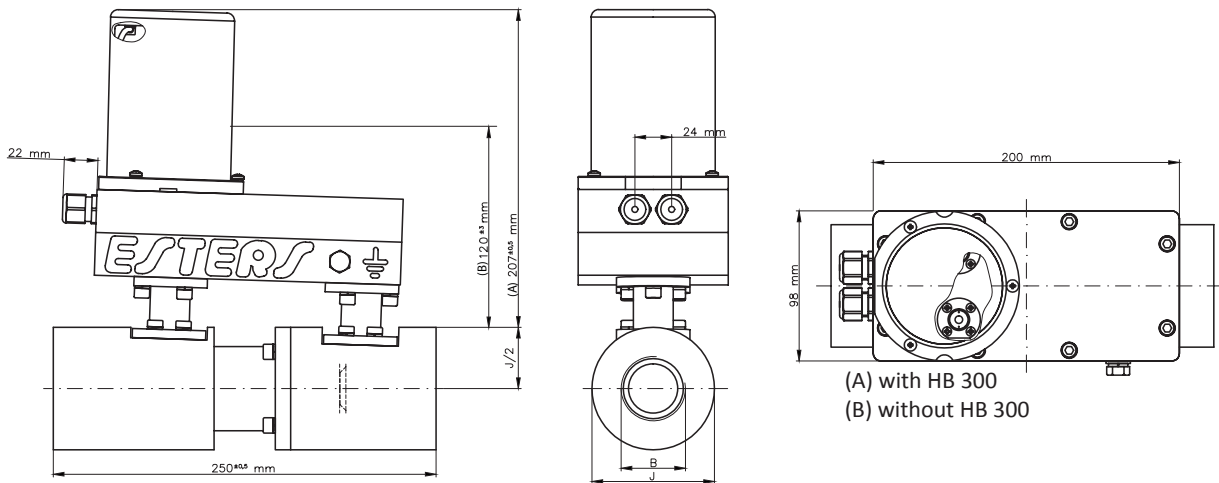

(A) with HB 300  
(B) without HB 300

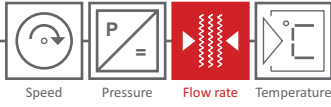

### GD 300 with flange

mm <sup>+0-1</sup> DN (nominal size)	mm <sup>+0-1</sup> L (S/L)	mm <sup>+0-1</sup> D	mm <sup>+0-1</sup> D <sub>H</sub>	weight (kg) ±5 % reduced flange	weight (kg) ±5 % solid flange
50	300	165	125	11	13
65	300	185	145	14	16
80	300	200	160	14	16
100	300/360	220	180	16/18	17/18
125	300	250	210	17	19
150	350/500	285	240	21/24	29/31
200	350	340	295	25	35
250	450	405	355	35	49
300	500	460	410	41	51
350	500	520	470	55	68
400	500	580	525	70	91

Rev.-no.: GD 300-DS 312 E-V1.4 2015-03-18

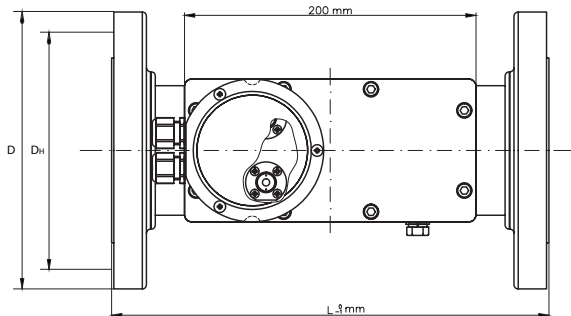
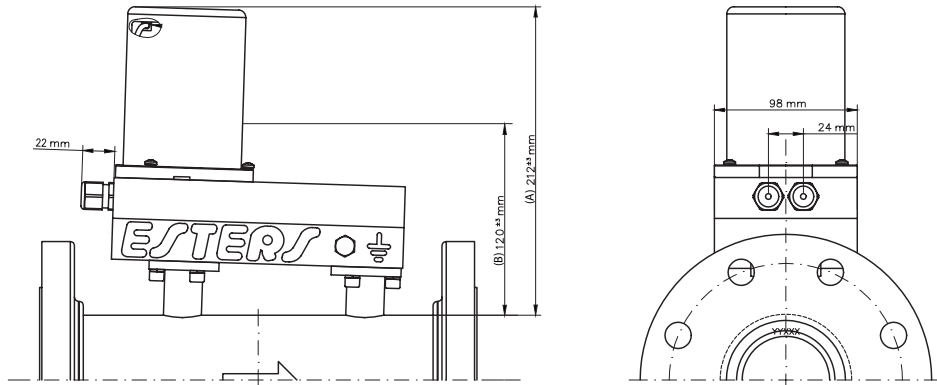

(A) with HB 300  
(B) without HB 300



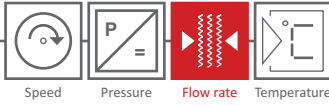

## Installation Instructions / Maintenance

Planning the project it has to be ensured that the pipe width is not increased by the gas meter to avoid measurement errors. The defined measurement ranges for individual nominal diameters must not be exceeded. A straight inlet zone of 10 x DN and an outlet zone of 5 x DN is required.

In the pipe network in front of the flowmeter, the gas velocity may not exceed supersonic speed. Supercritical pressure drops and pulsating flows must be avoided.

When installing the GD 300/GD 500 under the ceiling, a distance of at least 25 cm from the lid to the ceiling must be complied, that the lid can be removed for connecting the sensor cable.

In case of falling below the  $Q_{\min}$  (measuring range) display of measured values is not possible.



The flow meter GD 300/GD 500 can be installed in horizontal or vertical position. A condensate discharge is integrated into the measuring head, which guarantees the outflow of condensate of 100 % moist gas without sediments.

The inclined measuring head ensures the outflow of condensate when installed in horizontal pipes.

The oscillating measuring method of the Fluidistor principle requires no moving parts or sensitive sensor materials, creating a virtually maintenance-free operation of the GD 300/GD 500. The platinum wire sensor integrated in the head may be exchanged without removing the device from the pipe. A sensor change has no effect on the calibration of the flowmeter.



Installation of the GD 300 in a vertically falling line

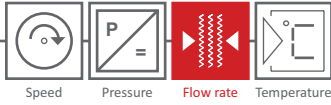

Speed Pressure Flow rate Temperature

## Ordering Information

### GD 500 with external pipe thread

GD 500						DESCRIPTION
EX-VERSION	Ex					with ATEX certification
PROCESS CONNECTION		-PA1				R 1/2"
		-PA2				G 1"
PRESSURE RANGE			00			0,5 bar
			10			10 bar
			16			16 bar
			40			40 bar
MATERIAL CONNECTION				-V2		V2A stainless steel
				-V4		V4A stainless steel
MATERIAL MEASURING HEAD				-AL		aluminium
				-V2		V2A stainless steel
				-V4		V4A stainless steel
INTEGRATED PRESSURE AND TEMPERATURE SENSORS					-P0	without
					-P1	press.: -50 ... +200 mbar, temp.: -50 to +150 °C *
					-P2	press.: 0 ... 30 bar, temp.: -50 to +150 °C *
REDUNDANT VERSION					R0	without
					R1	redundant platinum sensor *
					R2	redundant platinum sensor, pressure and temperature sensor *

\* only devices without ATEX certification



GD 500-PA100-V4-AL-P0R0



GD 500-PA200-V4-AL-P0R0

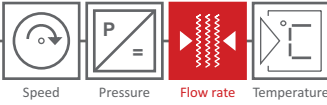

## GD 300 - DN 25 to DN 50 with internal pipe thread



GD 300				DESCRIPTION
EX-VERSION	Ex			with ATEX certification
PRESSURE RANGE		-025		DN 25 (thread Rp 1")
		-032		DN 32 (thread Rp 1 1/4")
		-040		DN 40 (thread Rp 1 1/2")
		-050		DN 50 (thread Rp 2")
ORIFICE		13		measurement range see table page 10
		15		
		17		
PROCESS CONNECTION			RP	internal pipe thread (Rp)
PRESSURE RANGE			00	0,5 bar
			10	10 bar
			16	16 bar
			40	40 bar
MATERIAL			-AL	aluminium
			-V2	V2A stainless steel
			-V4	V4A stainless steel
INTEGRATED PRESSURE AND TEMPERATURE SENSORS			-P0	without
			-P1	press.: -50 ... +200 mbar, temp.: -50 to +150 °C *
			-P2	press.: 0 ... 30 bar, temp.: -50 to +150 °C *
REDUNDANT VERSION			R0	without
			R1	redundant platinum sensor *
			R2	redundant platinum sensor, pressure and temperature sensor *

\* only devices without ATEX certification

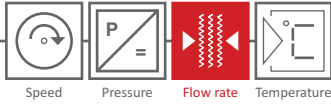

### GD 300 - DN 50 to DN 80 with flange



GD 300						DESCRIPTION	
EX-VERSION	Ex					with ATEX certification	
NOMINAL SIZE	-050					DN 50	
	-065					DN 65	
	-080					DN 80	
ORIFICE		13				measurement range see table page 10	
		15					
		17					
PIPE LENGTH			S			standard pipe length	
			L			version with extra length, see dimensions	
PROCESS CONNECTION			I			flange acc. to DIN EN-192-2/DIN2576	
			A			flange acc. to ASME B 16.5	
FLANGE VERSION				R		reduced flange (only ISO flange with a pressure range up to PN 10, bolt circle diameter PN 10)	
				F		solid flange	
BOLT CIRCLE DIAMETER				10		standard (ISO flange)	
				16		(ISO flange)	
				20		class 150 (ASME flange)	
				50		class 300 (ASME flange)	
PRESSURE RANGE				00		0,5 bar	
				10		10 bar	
				16		16 bar	
				40		40 bar	
				20		class 150 (ASME flange)	
MATERIAL					-AL	aluminium	
						-V2	V2A stainless steel
						-V4	V4A stainless steel
INTEGRATED PRESSURE AND TEMPERATURE SENSORS						-P0	without
						-P1	press.: -50 ... +200 mbar, temp.: -50 to +150 °C *
						-P2	press.: 0 ... 30 bar, temp.: -50 to +150 °C *
REDUNDANT VERSION						R0	without
						R1	redundant platinum sensor *
						R2	redundant platinum sensor, pressure and temperature sensor *
BALL VALVE						-AVF	ball valve (blocking valve)

\* only devices without ATEX certification

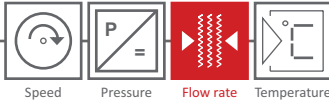

## GD 300 - DN 100 to DN 400 with flange

GD 300						DESCRIPTION		
EX-VERSION	Ex					with ATEX certification		
NOMINAL SIZE	-100					DN 100		
	-125					DN 125		
	-150					DN 150		
	-200					DN 200		
	-250					DN 250		
	-300					DN 300		
	-350					DN 350		
ORIFICE		25				measurement range see table page 10		
		27						
		30						
PIPE LENGTH			S			standard pipe length		
			L			version with extra length, see dimensions		
PROCESS CONNECTION			I			flange acc. to DIN EN-192-2/DIN2576		
			A			flange acc. to ASME B 16.5		
FLANGE VERSION				R		reduced flange (only ISO flange with a pressure range up to PN 10, bolt circle diameter PN 10)		
				F		solid flange		
BOLT CIRCLE DIAMETER				10		standard (ISO flange)		
				16		(ISO flange)		
				20		class 150 (ASME flange)		
				50		class 300 (ASME flange)		
PRESSURE RANGE				00		0,5 bar		
				10		10 bar		
				16		16 bar		
				40		40 bar		
				20		class 150 (ASME flange)		
MATERIAL					-AL	aluminium		
						-V2	V2A stainless steel	
						-V4	V4A stainless steel	
INTEGRATED PRESSURE AND TEMPERATURE SENSORS						-P0	without	
							-P1	press.: -50 ... +200 mbar, temp.: -50 to +150 °C *
							-P2	press.: 0 ... 30 bar, temp.: -50 to +150 °C *
REDUNDANT VERSION							R0	without
							R1	redundant platinum sensor *
							R2	redundant platinum sensor, pressure and temperature sensor *
BALL VALVE							-AVF	without ball valve (blocking valve)

\* only devices without ATEX certification

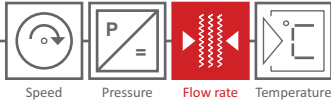

Speed Pressure Flow rate Temperature

## HB 300 - integrated calculator in the measuring head of the GD 300/GD 500

The gas flow meter GD 300/GD 500 can be equipped with an integrated calculator in the measuring head. This calculator converts the  $\text{m}^3/\text{h}$  to  $\text{Nm}^3/\text{h}$  in conjunction with pressure (fixed value) and temperature (fixed value).

Using the current output the measured value is directly transferred to a superior PLC system. Using the pulse output the signal is transferred to an external flow computer of the Esters series for application specific functions.



HB 300				DESCRIPTION
EX-VERSION	Ex			with ATEX certification
VERSION	-R0			standard
	-R1			redundant sensor *
STANDARDISATION		0		without standardisation
		1		DIN 1343
		2		DIN 6358
		3		DIN ISO 2533
		4		DIN 102/ISO 1-1975
CURRENT OUTPUT		0		without current output
		1		0 - 20 mA, load resistance 500 Ohm
		2		4 - 20 mA, load resistance 500 Ohm
OUTPUT RANGE CURRENT OUTPUT 0 (4) - 20 mA			00	without current output
			01	0 - 5 $\text{m}^3/\text{h}$ or $\text{Nm}^3/\text{h}$
			02	0 - 10 $\text{m}^3/\text{h}$ or $\text{Nm}^3/\text{h}$
			03	0 - 20 $\text{m}^3/\text{h}$ or $\text{Nm}^3/\text{h}$
			04	0 - 50 $\text{m}^3/\text{h}$ or $\text{Nm}^3/\text{h}$
			05	0 - 100 $\text{m}^3/\text{h}$ or $\text{Nm}^3/\text{h}$
			06	0 - 200 $\text{m}^3/\text{h}$ or $\text{Nm}^3/\text{h}$
			07	0 - 400 $\text{m}^3/\text{h}$ or $\text{Nm}^3/\text{h}$
			08	0 - 800 $\text{m}^3/\text{h}$ or $\text{Nm}^3/\text{h}$
			09	0 - 1.000 $\text{m}^3/\text{h}$ or $\text{Nm}^3/\text{h}$
			10	0 - 1.500 $\text{m}^3/\text{h}$ or $\text{Nm}^3/\text{h}$
			11	0 - 2.000 $\text{m}^3/\text{h}$ or $\text{Nm}^3/\text{h}$
			12	0 - 3.000 $\text{m}^3/\text{h}$ or $\text{Nm}^3/\text{h}$
			13	0 - 5.000 $\text{m}^3/\text{h}$ or $\text{Nm}^3/\text{h}$
			14	0 - 7.000 $\text{m}^3/\text{h}$ or $\text{Nm}^3/\text{h}$
			15	0 - 10.000 $\text{m}^3/\text{h}$ or $\text{Nm}^3/\text{h}$
PULSE WEIGHTING			0	pulse output (standard)
			1	0,0001 $\text{m}^3$ or $\text{Nm}^3$
			2	0,001 $\text{m}^3$ or $\text{Nm}^3$
			3	0,01 $\text{m}^3$ or $\text{Nm}^3$
			4	0,1 $\text{m}^3$ or $\text{Nm}^3$
			5	1 $\text{m}^3$ or $\text{Nm}^3$
			6	10 $\text{m}^3$ or $\text{Nm}^3$
			7	100 $\text{m}^3$ or $\text{Nm}^3$
			8	1.000 $\text{m}^3$ or $\text{Nm}^3$

\* only devices without ATEX certification